

MARS HABITAT 1:1 INTERACTIVE ARCHITECTURE PROTOTYPES

DIYA
GRAYSON
WAN
ANAN
ZHANG



Martian surface temperatures vary from lows of about $-143\text{ }^{\circ}\text{C}$ ($-225\text{ }^{\circ}\text{F}$) (at the winter polar caps) to highs of up to $35\text{ }^{\circ}\text{C}$ ($95\text{ }^{\circ}\text{F}$) (in equatorial summer).

We considered designing the habitat to the equatorial zone.



Martian surface temperatures vary from lows of about $-143\text{ }^{\circ}\text{C}$ ($-225\text{ }^{\circ}\text{F}$) (at the winter polar caps) to highs of up to $35\text{ }^{\circ}\text{C}$ ($95\text{ }^{\circ}\text{F}$) (in equatorial summer).

We considered designing the habitat to the equatorial zone.



Mars also lacks the magnetosphere that protects Earth. The average natural radiation level on Mars is about 40-50 times the average on Earth.

Habitats are to be equipped with radiation shielding, therefore best protection may be achieved with shelter built in natural caves or set into cliffs or hillsides.



Energy Requirements

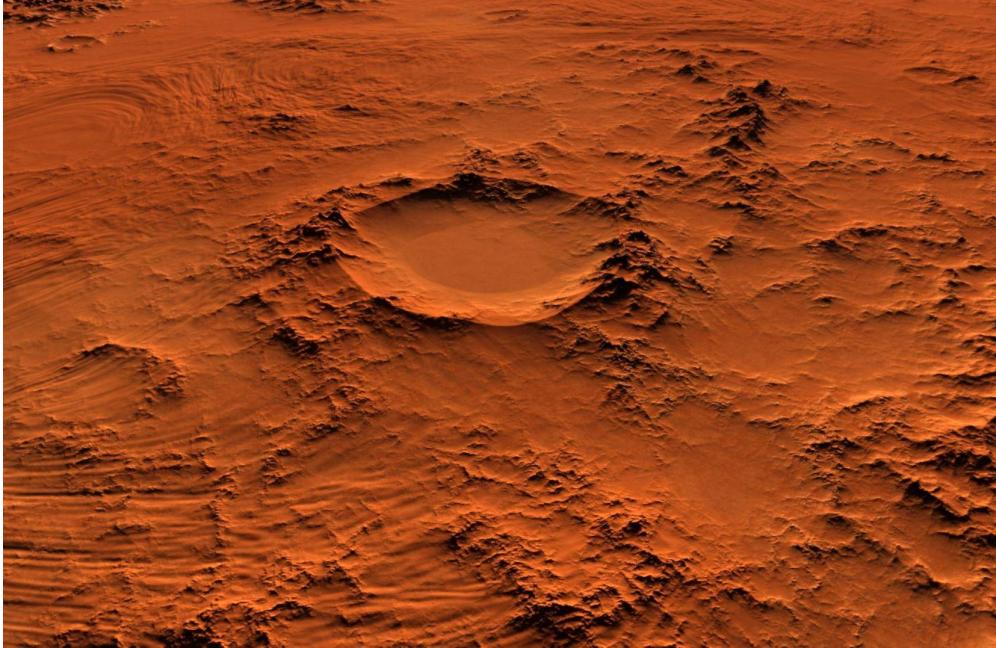

Considering the four main forms of energy production on Mars:

- Solar energy
- Nuclear energy
- Wind energy
- Geothermal energy

Our habitat will primarily use geothermal energy.

Water Recycling System

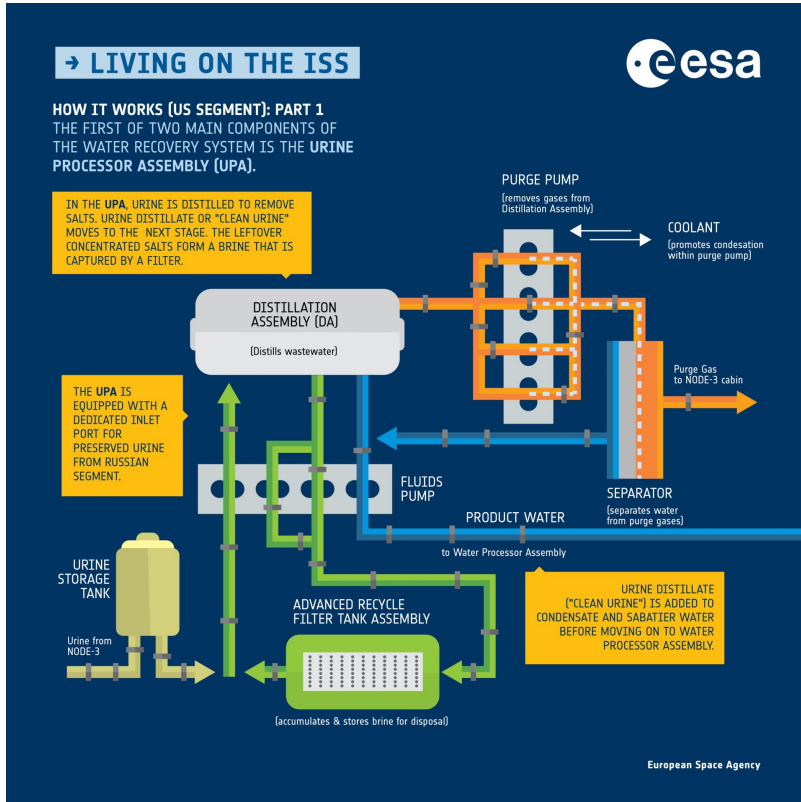

Learning about the recycling water on the International Space Station

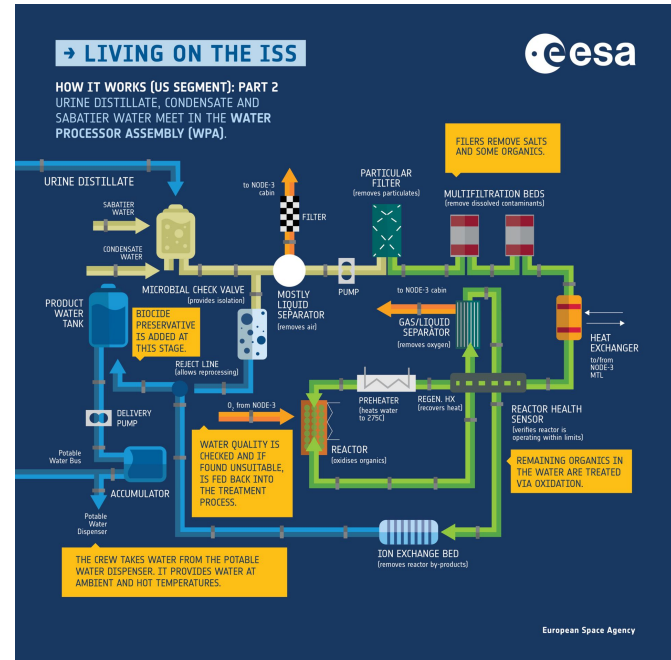

Air Lock Function for Entrance

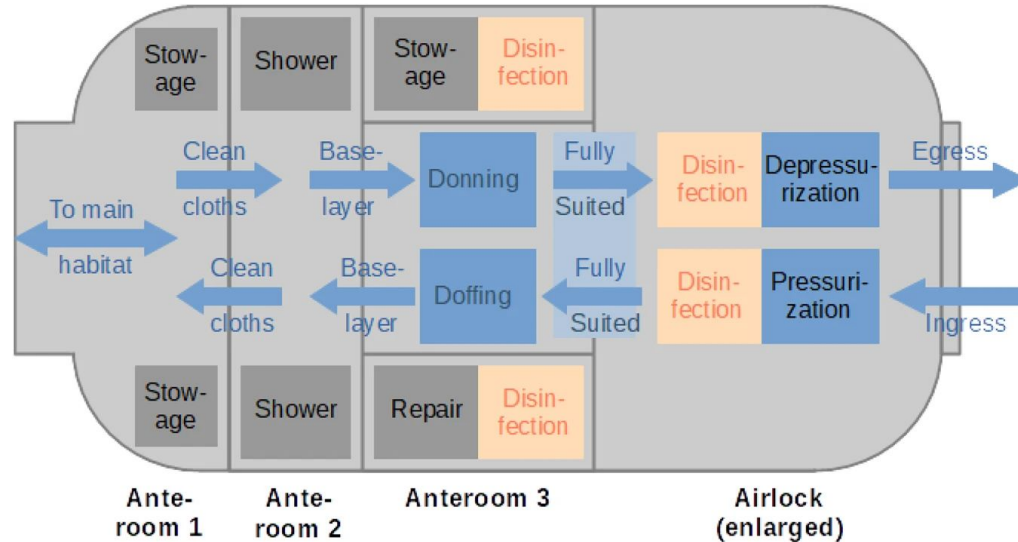

The airlock module is recommended to be divided into four sections based on information, with access to the main habitat through at least three anterooms.

Life Support System

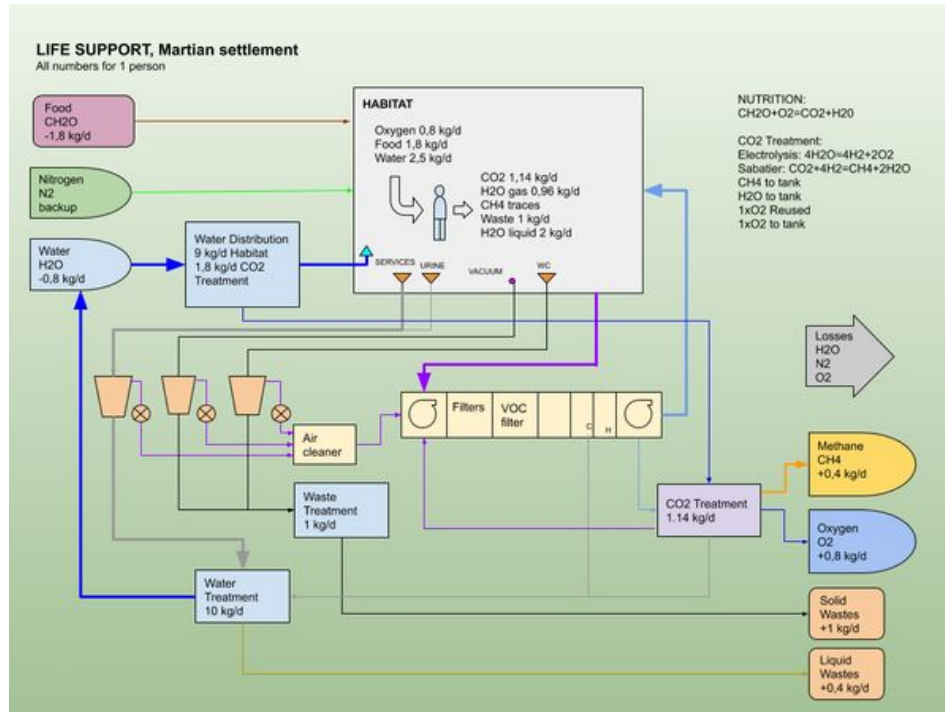

To produce food locally, a near-natural carbon cycle with the growing of food and the production of oxygen at the same time is required.

AEB_000001_0000
First MRO HiRISE image of Mars
Topographic model from photoclinometry
2.5m per image pixel, 5m per elevation point

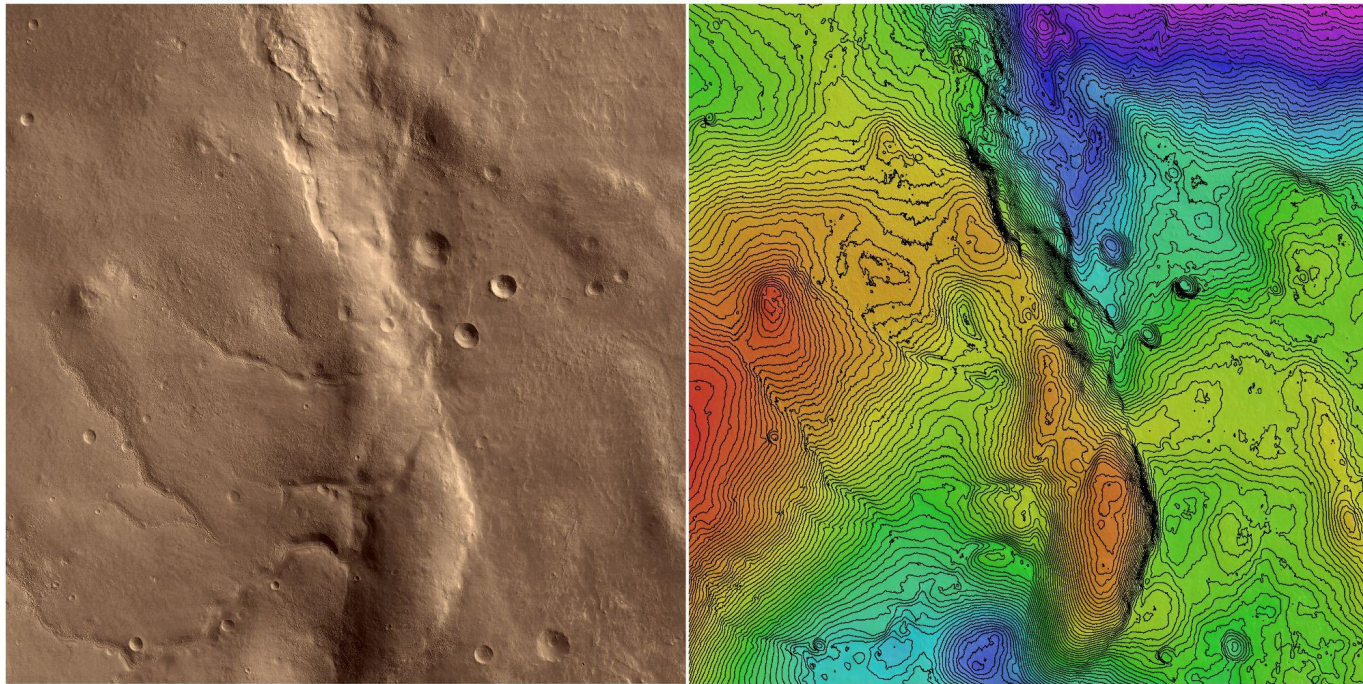

simulated natural color

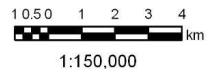

20m contour interval

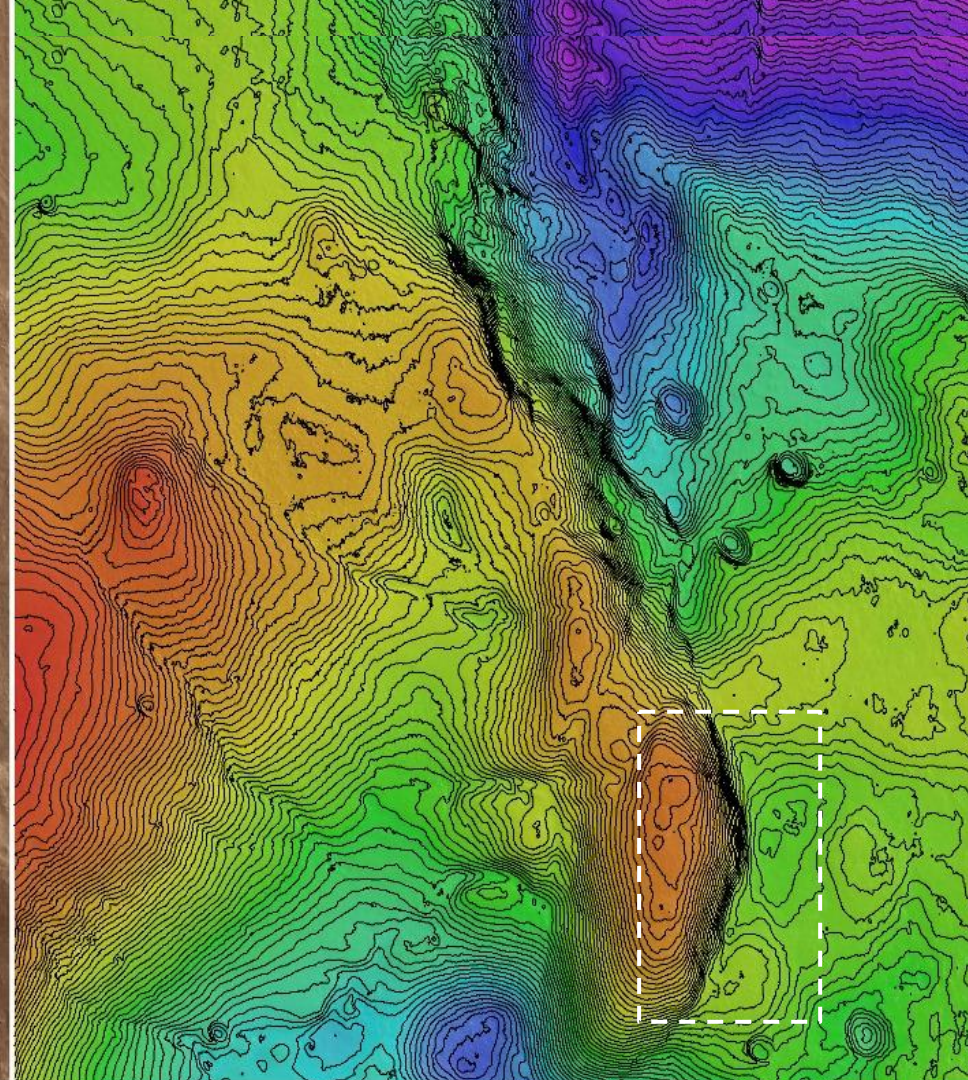
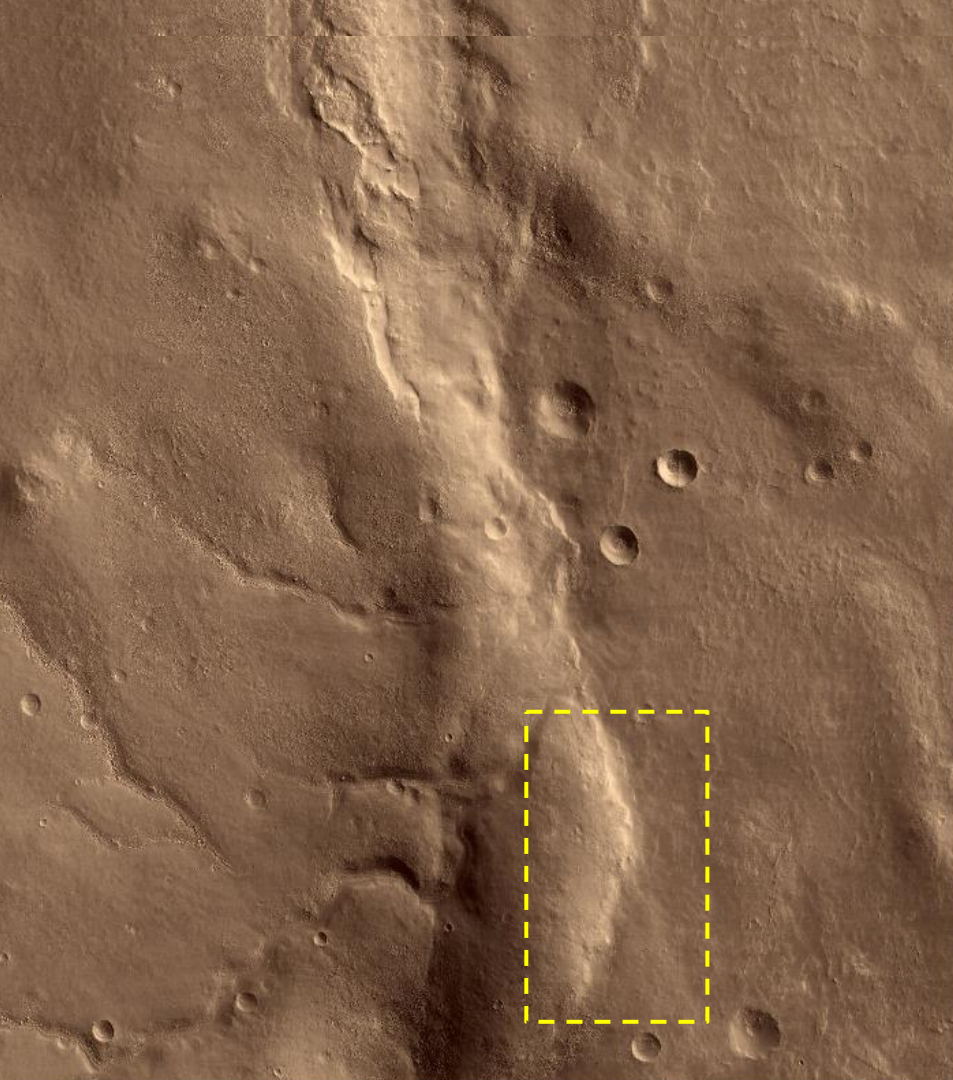

Valles Marineris

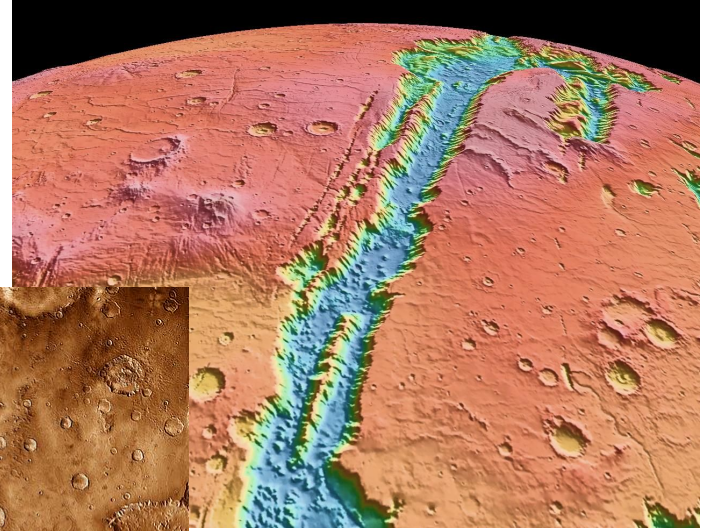
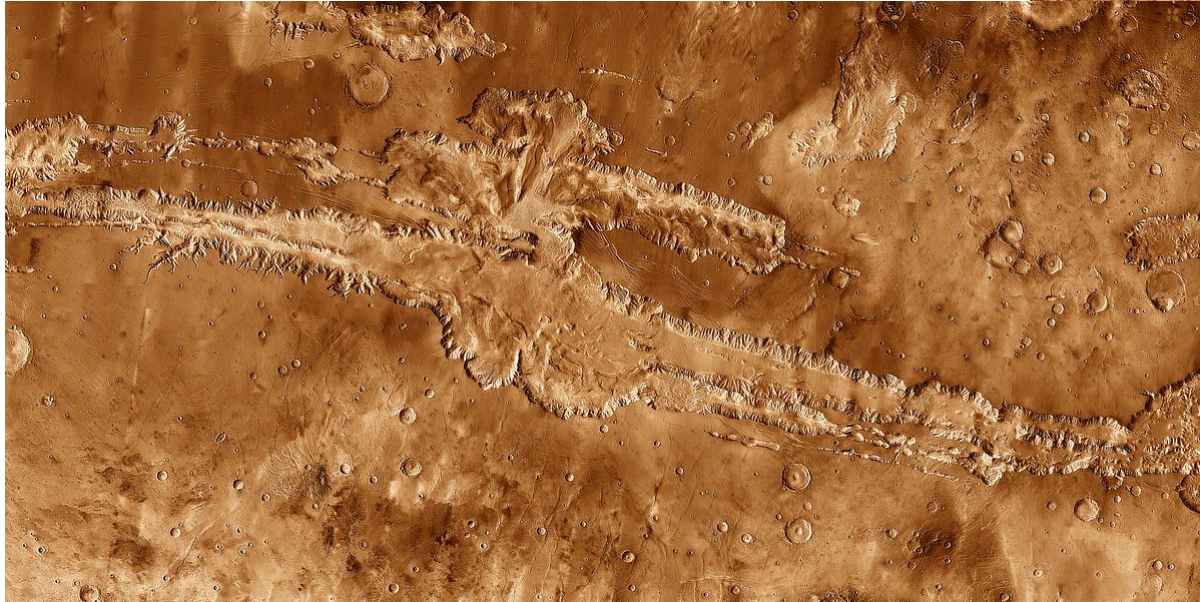

Components - Communal
Spaces+Workspace+Housing Units

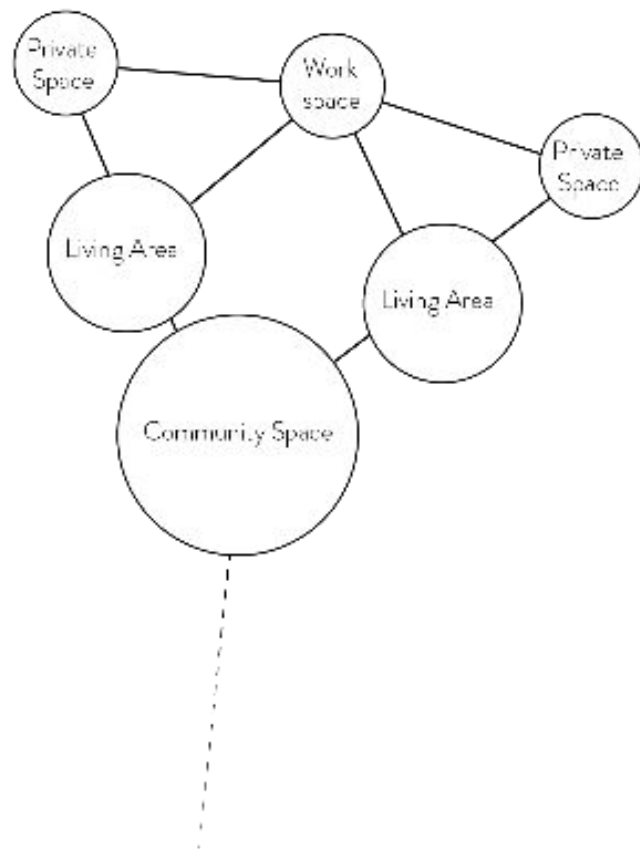

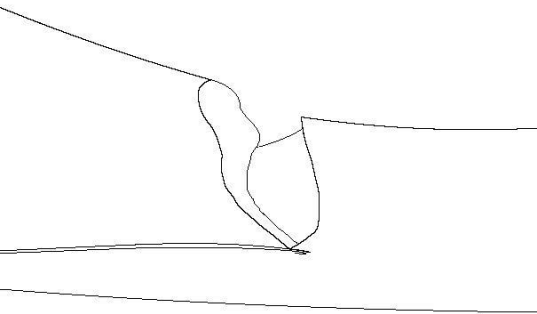

Site Section

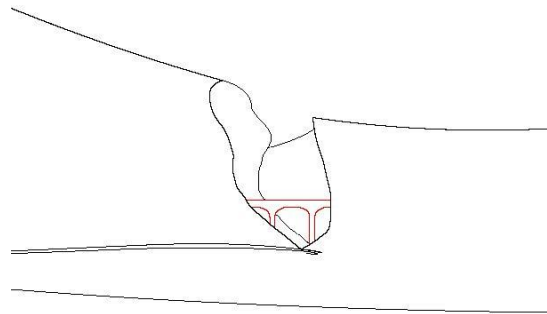

Support

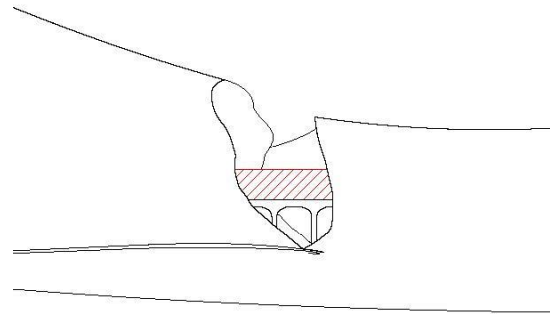

Level 1
Life Support, Rooms + Support Spaces
4.5m² 10m² 2.5m²

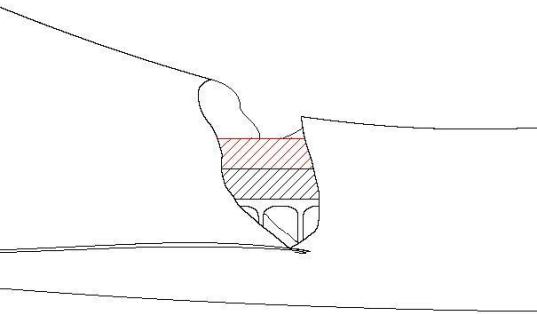

Level 2
Living Areas, Kitchen, Sanitation
10m² 4.5m²

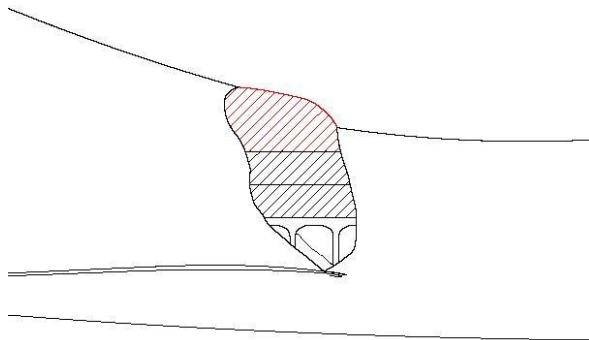

Level 3
Common Areas, Workspace, Machinery
12m² 4.5m² 4.5m²

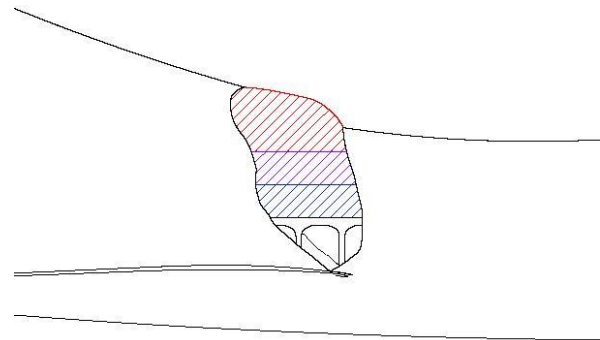

Totally

Design Development

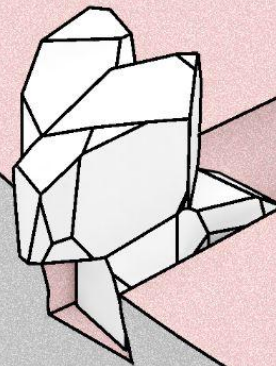
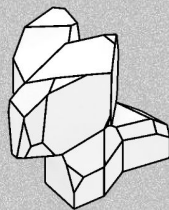
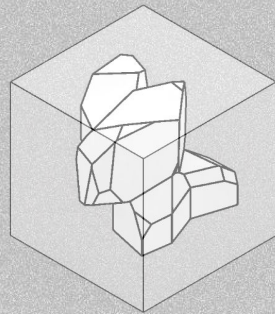
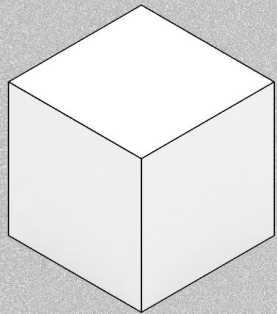

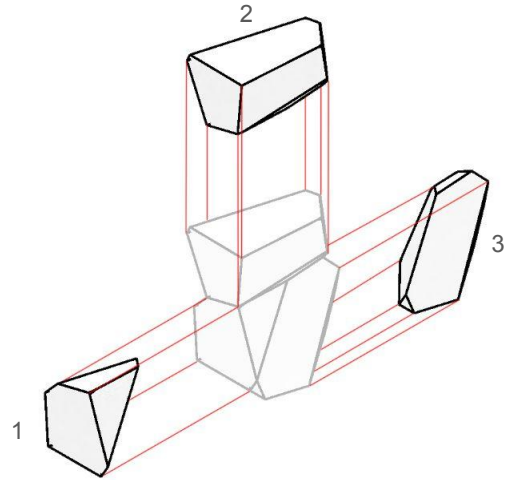
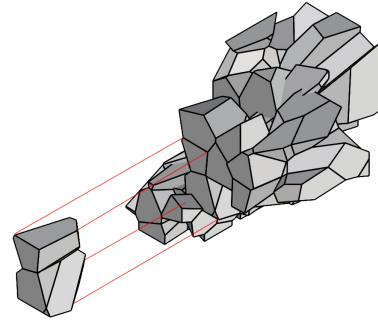
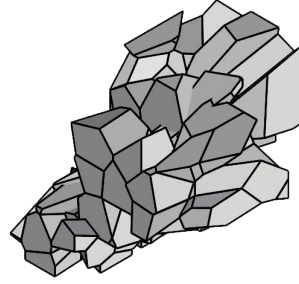
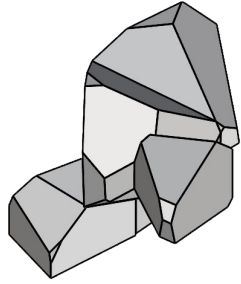

Form Generation

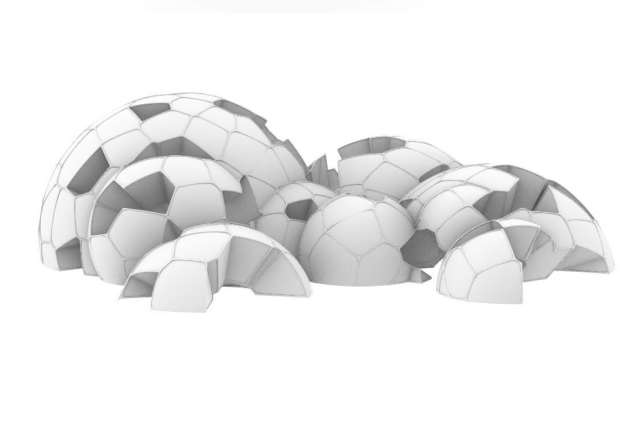
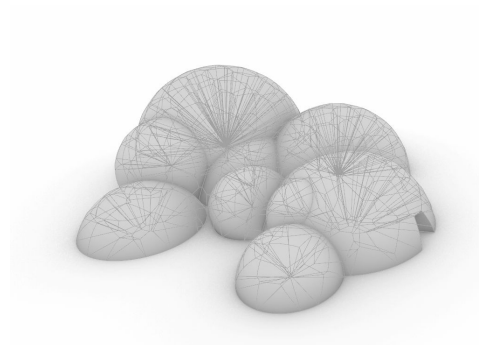
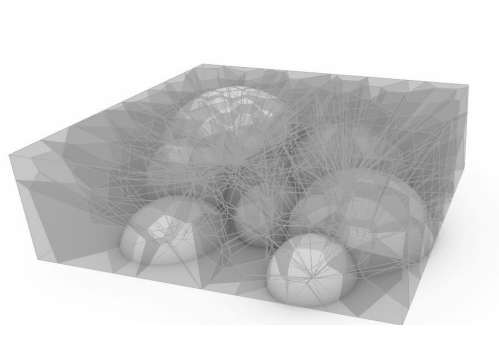
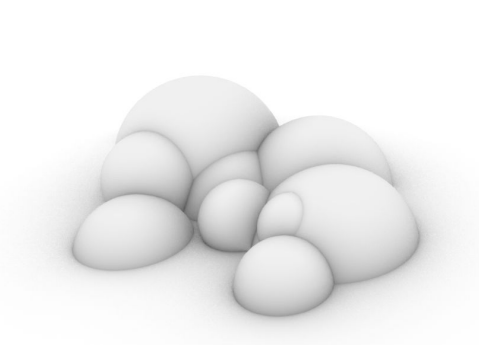

Fragment selection

Solar Panel

3d Printed Concrete units

Metal Support

